

### A. Package Content

Controller x 1, wall hanger x 1, user manual x 1, screwdriver x 1, kit pack x 1

Kit pack : screw x 4, screw anchors x 4, diode (1N4004) x 1, 4 pin cable x 1, 8 pin cable x 1, 9 pin cable x 1

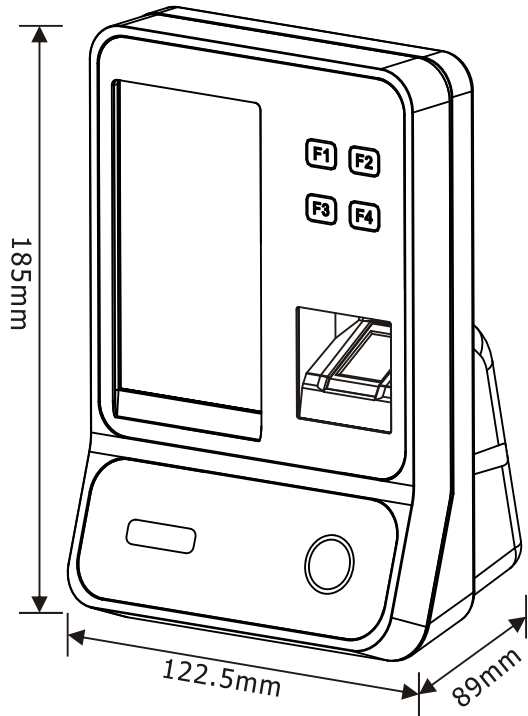

### B. Wall-Hanger Dimension

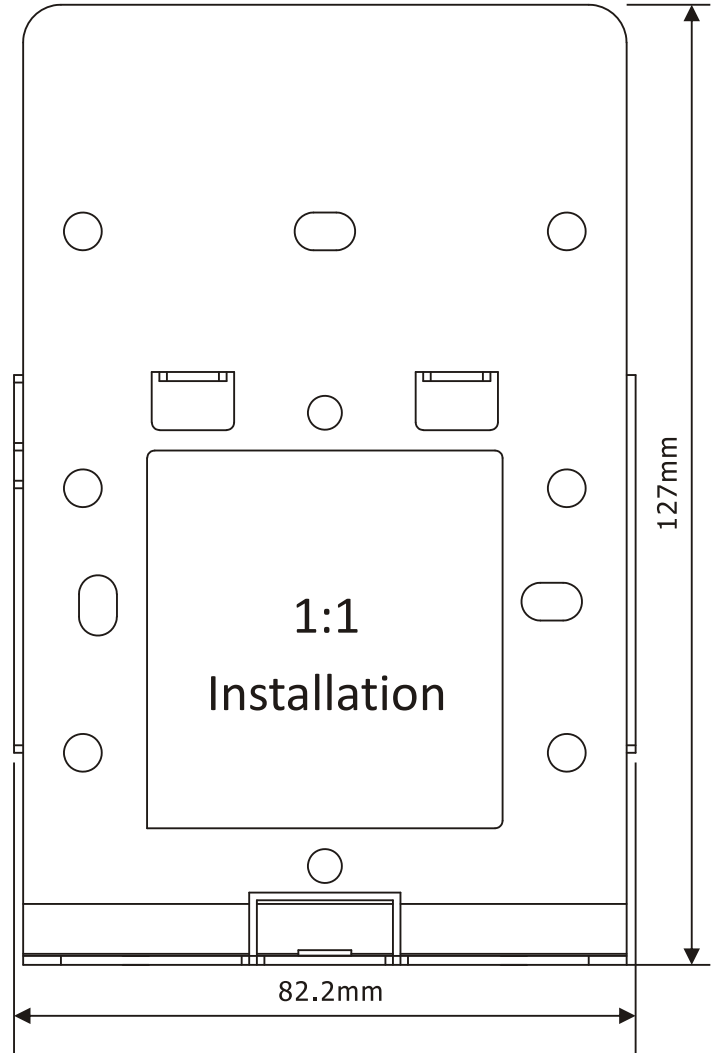

### C. Specification

- Dimension : 122.5 x 185 x 89(mm)
- Power : 9~24 VDC/ 1A
- Wiegand communication : Max to 100 meters
- RS485 communication : Max to 1000 meters
- Face recognition distance : 50 ~ 100 cm
- Recommend installation height 115 ~ 125 cm

### D. Installation Instructions

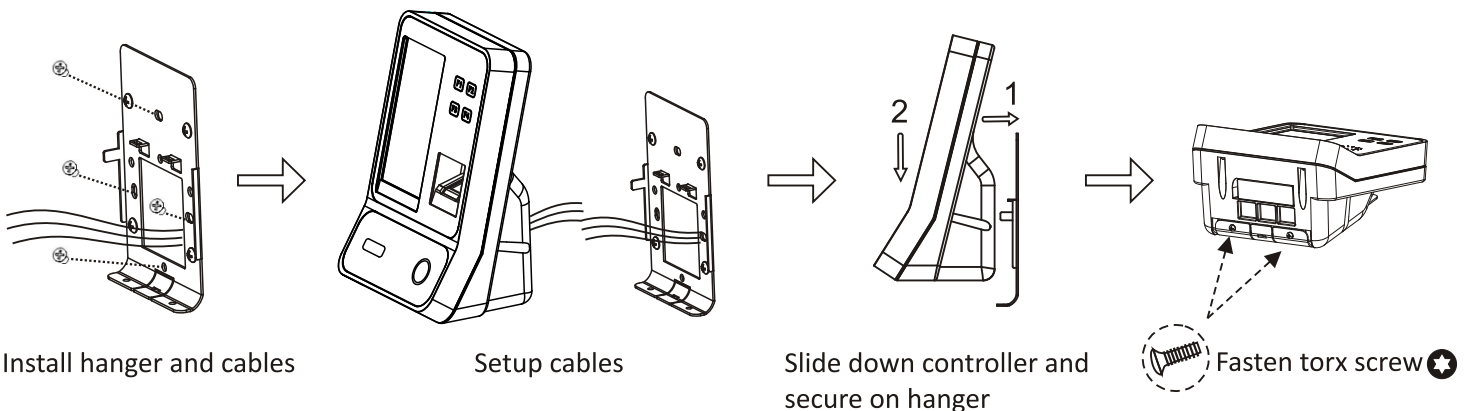

## E. Application Structure

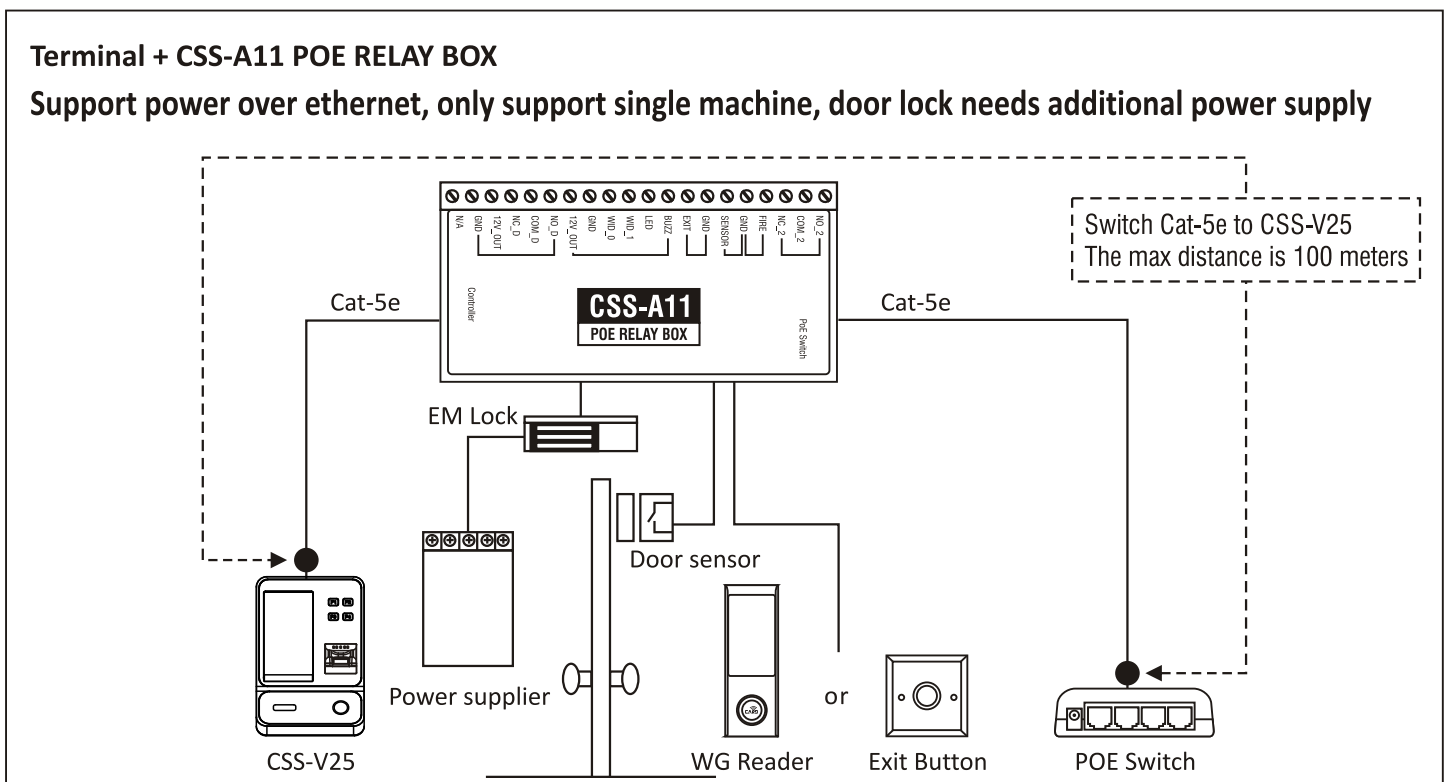
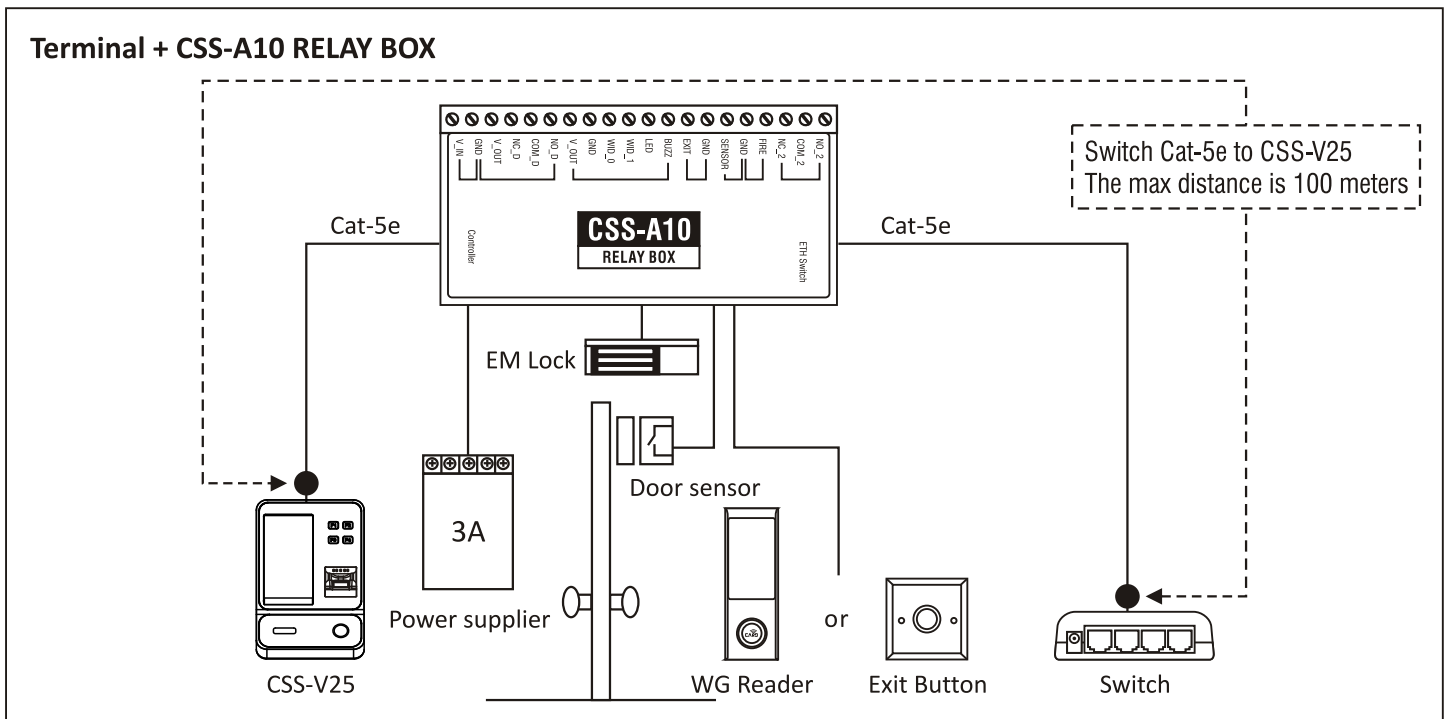
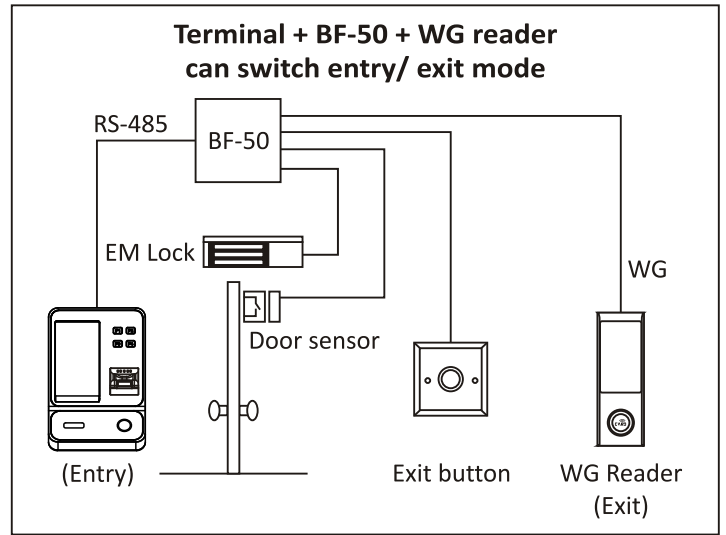
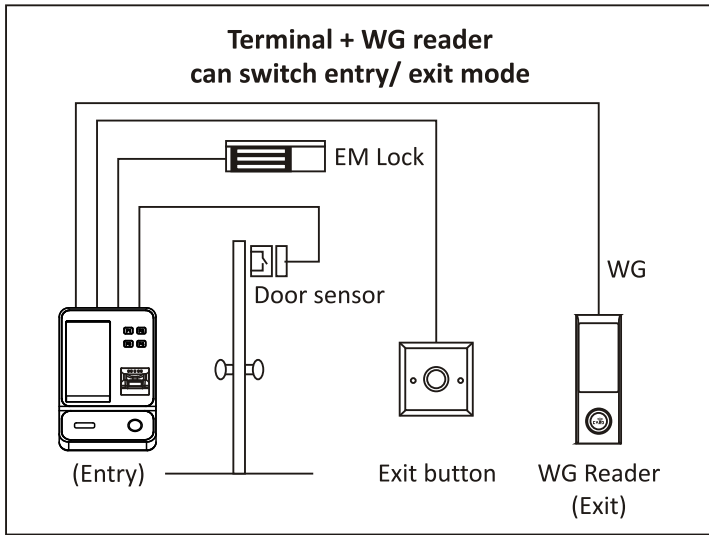

## F. Terminal Frontside Description

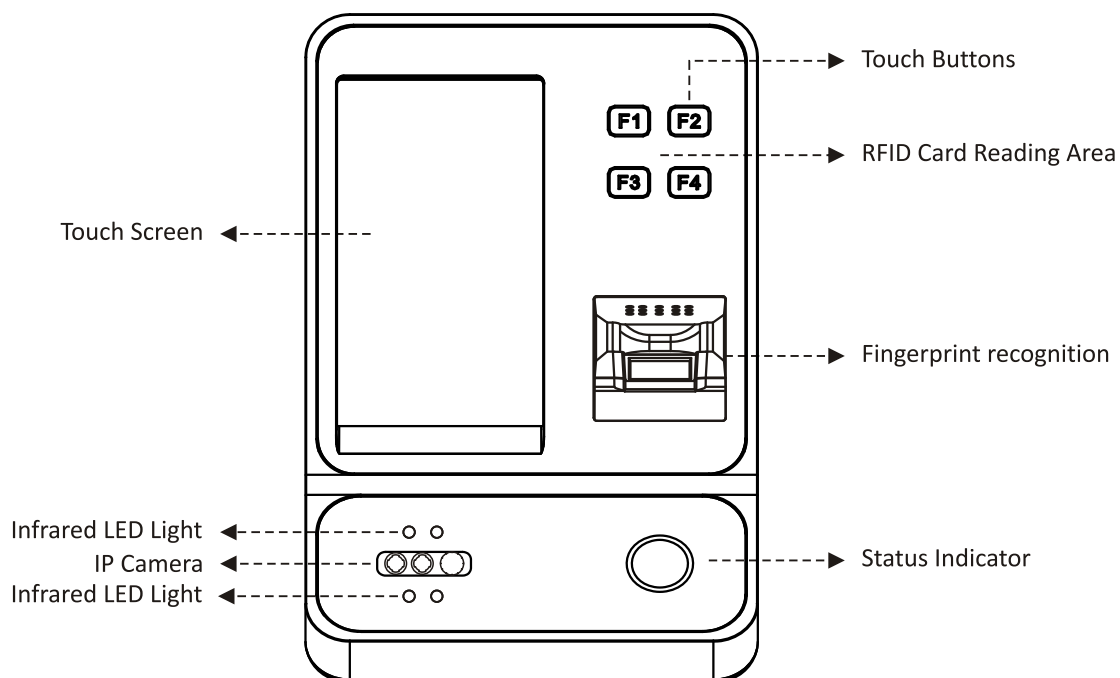

## G. Installation

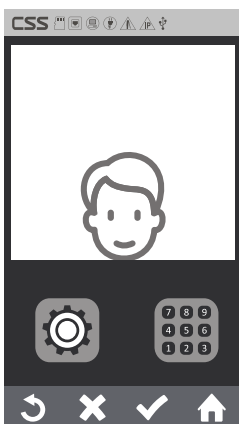

Recommend installation height	
Ground to bottom of the device (CM)	Users Height (CM)
115	153~190
117	155~195
119	157~200
121	159~205
123	161~210
125	163~215

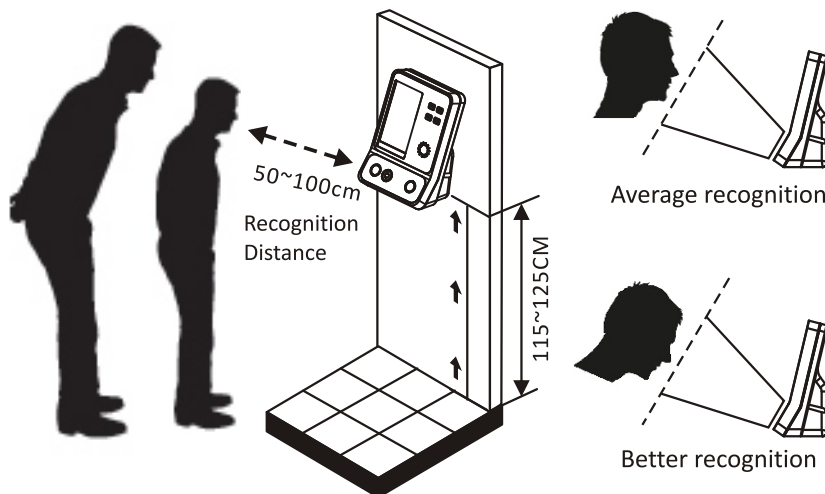

Recognition distance is 50~100 (cm)

For shorter person minimum requirement is have chin align to the lower edge of the display frame

Please refer to above chart for best installation of device vs user

Please bow your head slightly to have better recognition rate

## H. installation Environment

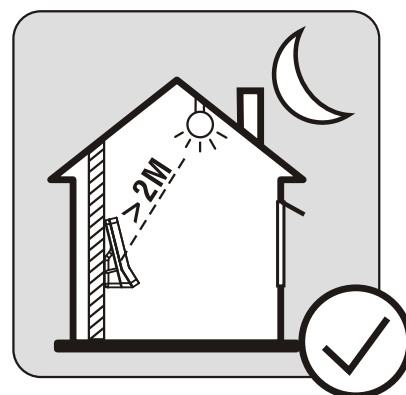
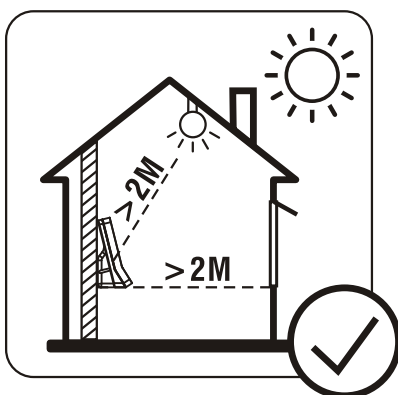
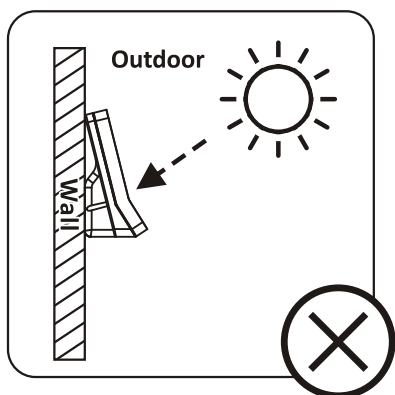

Please avoid directly sunshine and keep at least 2 meters away from lights

## I. Terminal Backside Explanation

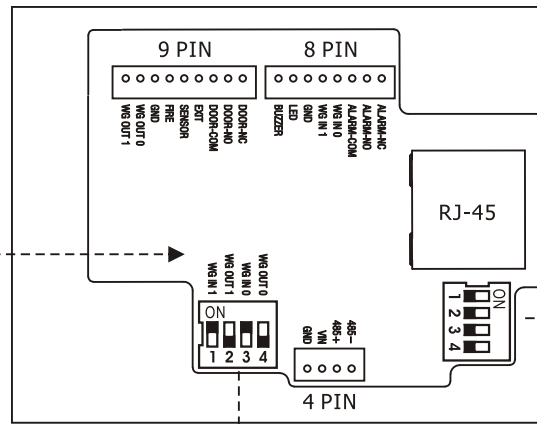
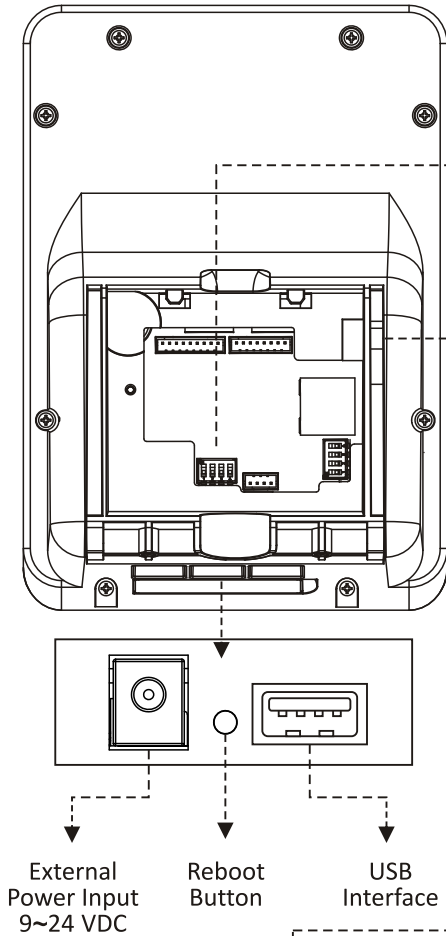

### WG Setting Description (input and output select one only)

WG Input (Default Setting) For connect WG Reader		
WG Output Web setting also needs to be changed (At communication setup page)		

### External BF-50/ CSS-A10/ A11 setting instructions

External BF-50 (Default Setting)		
External CSS-A10/ A11		

## J. Cable Diagram

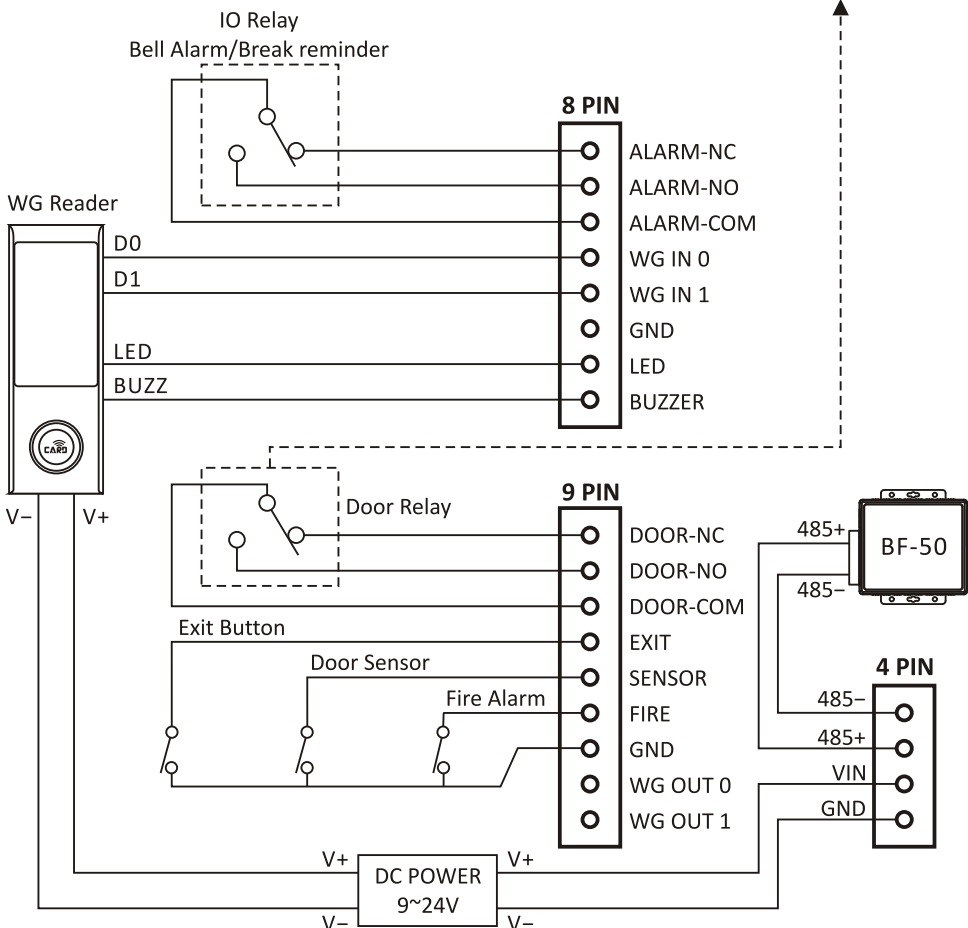

## K. Cable Description

### 4 PIN

485-	GRAY	For Relay Box BF-50
485+	BROWN	
VIN	RED	DC 9~24V (1A)
GND	BLACK	

### 8 PIN

ALARM-NC	YELLOW BLACK	IO Relay Bell Alarm/ Break reminder
ALARM-NO	WHITE BLACK	
ALARM-COM	GREEN BLACK	
WG IN 0	RED WHITE	WG Input Connect WG Reader
WG IN 1	BLACK WHITE	
GND	BLACK	GND
LED	ORANGE	Control WG Reader LED/ Buzzer Action
BUZZER	PINK BLACK	

### 9 PIN

DOOR-NC	YELLOW	Door Relay
DOOR-NO	WHITE	
DOOR-COM	GREEN	
EXIT	VIOLET	Exit Button
SENSOR	BLUE	Door Sensor
FIRE	PINK	Fire Alarm
GND	BLACK	GND
WG OUT 0	GRAY BLUE	WG Output
WG OUT 1	ORANGE BLACK	